

PROBE INFORMATION

Model Number	Page
4005MK	7
6030MK	6
9150	12
9151	12
9152	12
10040	11
10045	11
10046	11
10051	11
10052	11
31901	3
31903	6
31905	9
31907	7
39032	6
39035	3
39138	9
49122	5
49126	4
49127	4
49135	4
49136	9
49138	9
49140	5
50001	7
50008	7
50010	7
50012	8
50014	8
50069	8
50101	4
50121	10
50143	4
50145	4
50200	5
50207	5
50208	6
50209	5
50210	5
50216	5
50263	5
50264	5
50293	5
50294	5
50302	6
50305	6
50306	6
50316	8
50318	8
50319	9
50332	7
50334	3
50335	3
50336	3
50337	3
50338	7
50360	3
50361	3
50405	9
50415	10
50416	9
50426	4
50427	4
50701	10
53032/N	11
53035	11
53040/N	11
54032/N	11
54035	11
54040/N	11
55032/N	10
55035	10
55040/N	10
PD1389-10	11
PD1389-52	11

The response of a thermocouple probe of temperature versus time can be graphed as an exponential function. One time constant is defined as the time required to reach 63.2% of the temperature change. Two time constants is 86.5% and three is 95% of the temperature change. At Cooper-Atkins, the response time is stated at three time constants of the temperature change. Response times are intended as a general guideline and can differ in actual usage conditions. Any testing done at the factory is under controlled conditions.

Thermocouple Types: The probe thermocouple type J, K, or T must match that of the instrument. Specifications shown are for thermocouple Type K models. Most probes are also available in thermocouple types J and T. In some cases, the upper temperature limits for types J and T may differ from that shown in the catalog. Call for availability or specifications.

Accuracy Tolerances for Standard Thermocouples (A.N.S.I. MC 96.1 - 1982)

Type K Thermocouples

Above 32°F or 0°C: $\pm 0.75\%$ of reading (or $\pm 4^\circ\text{F}$ (2.2°C) whichever is greater) to 2,282°F (1,250°C)
 Below 32°F (0°C): $\pm 2.0\%$ of reading (or $\pm 4^\circ\text{F}$ (2.2°C) if greater) to -328°F (-200°C)

Type J Thermocouples

Above 32°F or 0°C: $\pm 0.75\%$ of reading (or $\pm 4^\circ\text{F}$ (2.2°C) whichever is greater) to 1,382°F (750°C)
 Below 32°F (0°C): No A.N.S.I. specification.

Type T Thermocouples









Above 32°F or 0°C: $\pm 0.75\%$ of reading (or $\pm 1.8^\circ\text{F}$ (1.0°C) whichever is greater) to 662°F (350°C)
 Below 32°F (0°C): $\pm 1.5\%$ of reading (or $\pm 1.8^\circ\text{F}$ (1.0°C) if greater) to -328°F (-200°C)

One Year Warranty:

Cooper-Atkins Thermocouple probes are covered by the industry's leading warranty program. All Cooper-Atkins probes are guaranteed to be free of defects in workmanship and materials for one (1) year.





Cable Differences

- Probes with special limits of error cables are available for quote to high volume users.
- Avoid over-stretching or kinking the probe cables for longest life
- Detach probe from the instrument by holding the plug firmly, do not pull plug out by the cable

	Flexible Cable with PVC Jacket: PVC insulation on primaries and outer jacket. PVC offers good abrasion and chemical resistance.
	Coiled Retractable Cable: Polyurethane outer jacket. PFA Teflon® insulation on primaries. Polyurethane offers excellent abrasion resistance and good chemical resistance.
	Flexible Cable with Teflon® Jacket: FEP Teflon® insulation on primaries and outer jacket. Teflon® offers excellent abrasion and chemical resistance.
	Flexible Cable with Fluoroelastomer Jacket: Custom, patented Cooper-Atkins cable with Kevlar® fillers and metal braid for strength. Fluoroelastomer offers outstanding abrasion and chemical resistance. Connector design for use of Wrap & Stow Thermocouple Instruments
	Flexible Armored Cable: FEP Teflon® jacketed cable protected by stainless steel flexible armored hose. The armored hose protects the cable and offers outstanding abrasion, cut and chemical resistance.
	Flexible Cable with Silicone Jacket: Silicone outer jacketed cable with Kevlar® fillers and metal braid for strength. Silicone offers good abrasion and chemical resistance.
	Flexible Cable with Woven Stainless Steel Overbraid: Kapton® insulation on primaries and outer jacket. Cable protected by stainless steel overbraid. Offers outstanding abrasion and cut resistance and good chemical resistance.
	Flexible Cable with Fiberglass Jacket: Woven fiberglass insulation with a resin coating on primaries and outer jacket. Excellent for high temperature applications. Not recommend for abrasive, high flex or foodservice applications.

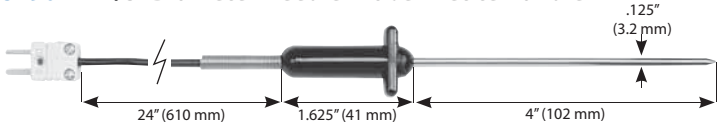
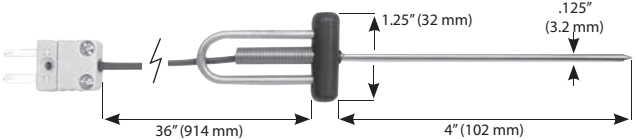
STANDARD NEEDLE PROBES

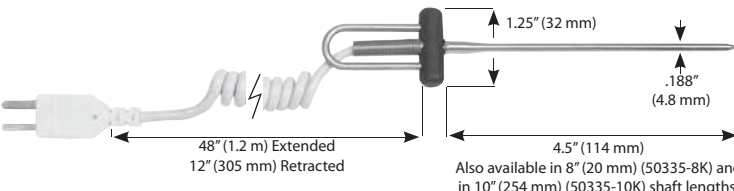
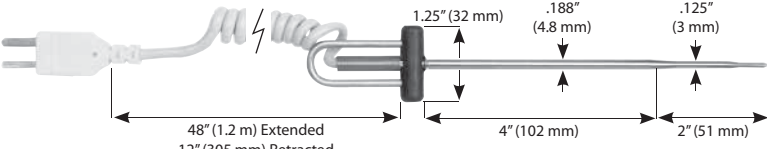
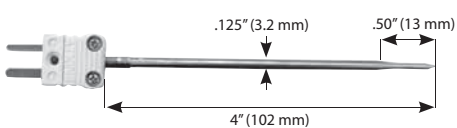
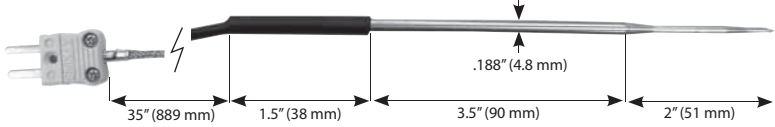
Used to measure insertion and immersion temperatures of food products including solids, semi-solid liquids and more. Rugged design for quick response and dependable performance.

<p>31901-K 1/8" Diameter Needle Probe - Petite Handle</p>  <p>Temp Range: -40° to 400°F (-40° to 205°C) Max Tip/Cable Temp: 400°F (205°C) Max Handle Temp: 300°F (149°C) Response Time: 4 seconds, liquid Unit Weight: 1 oz. (28 gms.) Flexible Cable with Silicone Jacket</p>	<p>Temp Range: -40° to 400°F (-40° to 205°C) Max Tip/Cable Temp: 400°F (205°C) Max Handle Temp: 280°F (138°C) Response Time: 4 seconds, liquid Unit Weight: 1 oz. (28 gms.) Flexible Cable with Teflon Jacket</p>
<p>39035 (J, K or T) 1/8" Diameter Needle Probe - Straight Cable</p>  <p>Temp Range: -100° to 500°F (-73° to 260°C) Max Tip Temp: 500°F (260°C) Max Cable/Handle Temp: 400°F (205°C) Response Time: 1 second, liquid Unit Weight: 2 oz. (57 gms.) Flexible Cable with Fluoroelastomer Jacket</p>	<p>Temp Range: -40° to 500°F (-40° to 260°C) Max Tip Temp: 500°F (260°C) Max Cable Temp: 176°F (80°C) Handle Temp: 280°F (138°C) Response Time: 4 seconds, liquid Unit Weight: 2 oz. (57 gms.) Coiled Retractable Cable</p>
<p>50334-K 4" DuraNeedle Probe</p>  <p>Temp Range: -40° to 500°F (-40° to 260°C) Max Tip Temp: 500°F (260°C) Max Cable Temp: 176°F (80°C) Handle Temp: 280°F (138°C) Response Time: 2 seconds, liquid Unit Weight: 2 oz. (57 gms.) Coiled Retractable Cable</p>	<p>Temp Range: -40° to 500°F (-40° to 260°C) Max Tip Temp: 500°F (260°C) Max Cable Temp: 176°F (80°C) Handle Temp: 280°F (138°C) Response Time: 2 seconds, liquid Unit Weight: 2 oz. (57 gms.) Coiled Retractable Cable</p>
<p>50335 (J, K or T) 1/8" Diameter Needle Probe - Coiled Cable</p>  <p>Temp Range: -40° to 500°F (-40° to 260°C) Max Tip Temp: 500°F (260°C) Max Cable Temp: 176°F (80°C) Handle Temp: 280°F (138°C) Response Time: 4 seconds, liquid Unit Weight: 2 oz. (57 gms.) Coiled Retractable Cable</p>	<p>Temp Range: -40° to 500°F (-40° to 260°C) Max Tip Temp: 500°F (260°C) Max Cable Temp: 176°F (80°C) Handle Temp: 280°F (138°C) Response Time: 2 seconds, liquid Unit Weight: 2 oz. (57 gms.) Coiled Retractable Cable</p>
<p>50336 (J, K or T) 6" DuraNeedle Probe</p>  <p>Temp Range: -100° to 500°F (-73° to 260°C) Max Tip Temp: 500°F (260°C) Max Cable Temp: 176°F (80°C) Response Time: 1 second, liquid Unit Weight: .5 oz. (14 gms.)</p>	<p>Temp Range: -100° to 500°F (-73° to 260°C) Max Tip Temp: 500°F (260°C) Max Cable Temp: 176°F (80°C) Response Time: 1 second, liquid Unit Weight: .5 oz. (14 gms.)</p>
<p>50337-K DuraNeedle - Direct Connect</p>  <p>Temp Range: -40° to 500°F (-40° to 260°C) Max Tip Temp: 500°F (260°C) Max Cable Temp: 600°F (316°C) Response Time: 2 seconds, liquid Unit Weight: 1 oz. (28 gms.) Flexible Cable with Woven Stainless Steel Overbraid</p>	<p>Temp Range: -40° to 500°F (-40° to 260°C) Max Tip Temp: 500°F (260°C) Max Cable Temp: 600°F (316°C) Response Time: 2 seconds, liquid Unit Weight: 1 oz. (28 gms.) Flexible Cable with Woven Stainless Steel Overbraid</p>
<p>50360-K Oven Needle Probe</p>  <p>Temp Range: -40° to 500°F (-40° to 260°C) Max Tip/Handle/Cable Temp: 400°F (205°C) Response Time: 4 seconds, liquid Unit Weight: 6 oz. (170 gms.) Flexible Armored Cable</p>	<p>Temp Range: -40° to 500°F (-40° to 260°C) Max Tip/Handle/Cable Temp: 400°F (205°C) Response Time: 4 seconds, liquid Unit Weight: 6 oz. (170 gms.) Flexible Armored Cable</p>
<p>50361-K Armored Cable DuraNeedle Probe</p>  <p>Temp Range: -40° to 500°F (-40° to 260°C) Max Tip Temp: 500°F (260°C) Max Cable Temp: 176°F (80°C) Handle Temp: 280°F (138°C) Response Time: 2 seconds, liquid Unit Weight: 2 oz. (57 gms.) Coiled Retractable Cable</p>	<p>Temp Range: -40° to 500°F (-40° to 260°C) Max Tip Temp: 500°F (260°C) Max Cable Temp: 176°F (80°C) Handle Temp: 280°F (138°C) Response Time: 2 seconds, liquid Unit Weight: 2 oz. (57 gms.) Coiled Retractable Cable</p>

HEAVY DUTY NEEDLE PROBES

For insertion applications where enhanced durability or a larger handle is desired. Rugged design for quick response. Applications include frozen foods, solid or semi-solid meats and asphalt temperatures.

Some frozen products are soft or pliable and some products are hard and solid. It is impossible to recommend one probe for all frozen food applications. Avoid using the probe tip as an ice pick. When measuring temperatures of hard frozen products it is ALWAYS recommended to pre-drill the hole first, then insert the smaller needle.

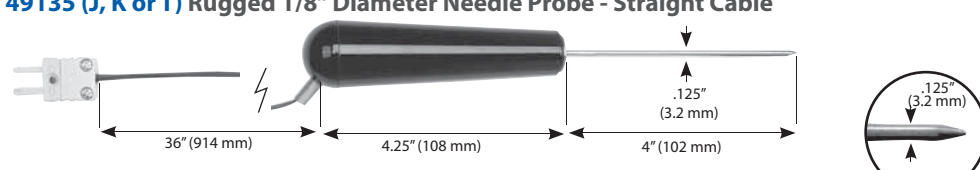
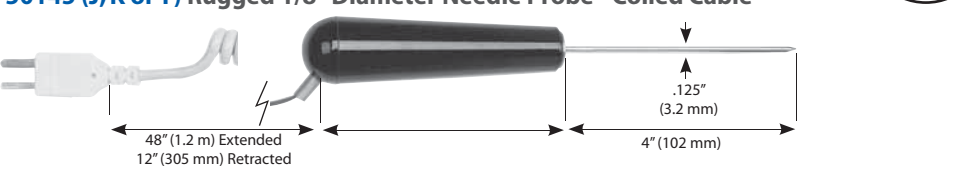
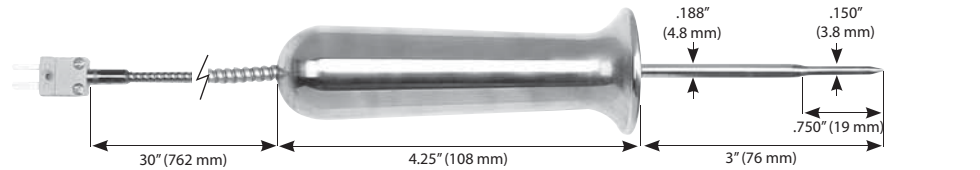
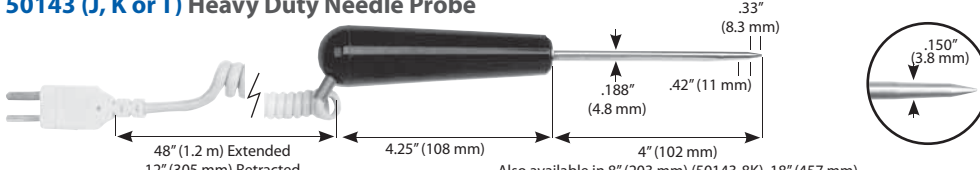
<p>49135 (J, K or T) Rugged 1/8" Diameter Needle Probe - Straight Cable</p> 	<p>49135 Temp Range: -40° to 400°F (-40° to 205°C) Max Tip/Cable Temp: 400°F (205°C) Max Handle Temp: 325°F (163°C) Flexible Cable with Teflon Jacket</p> <p>50145 Temp Range: -40° to 500°F (-40° to 260°C) Max Tip Temp: 500°F (260°C) Max Cable Temp: 176°F (80°C) Max Handle Temp: 325°F (163°C) Coiled Retractable Cable</p> <p>Response Time: 4 seconds, liquid Unit Weight: 4 oz. (113 gms.)</p>
<p>50145 (J, K or T) Rugged 1/8" Diameter Needle Probe - Coiled Cable</p> 	<p>Temp Range: -40° to 400°F (-40° to 205°C) Max Tip/Handle/Cable Temp: 400°F (205°C) Response Time: 4 seconds, liquid Unit Weight: 1 lb (454 gms.) Stainless Steel Handle and Flexible Armored Cable</p> <p>Very heavy duty with large handle grip enabling insertion into hard products.</p>
<p>50101 (J, K or T) Frozen Product Probe</p> 	<p>Temp Range: -40° to 400°F (-40° to 205°C) Max Tip Temp: 500°F (260°C) Max Cable Temp: 176°F (80°C) Max Handle Temp: 325°F (163°C) Response Time: 5 seconds, liquid Unit Weight: 5 oz. (142 gms.) Coiled Retractable Cable</p>
<p>50143 (J, K or T) Heavy Duty Needle Probe</p>  <p>Also available in 8" (203 mm) (50143-8K), 18" (457 mm) (50143-18K) and 24" (610 mm) (50143-24K) shaft lengths.</p>	

HIGH TEMPERATURE NEEDLE PROBES

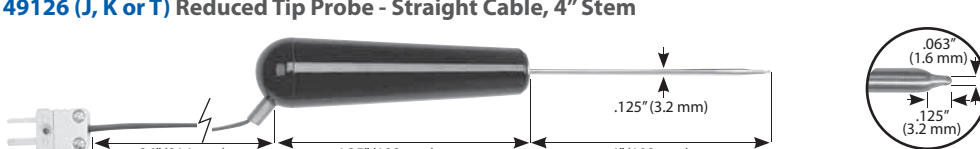
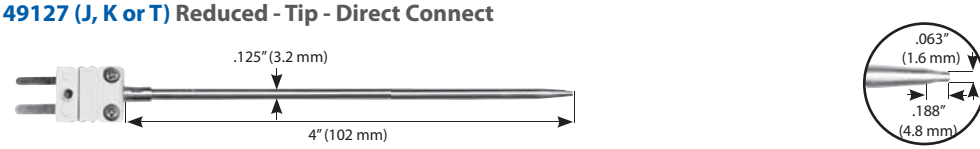
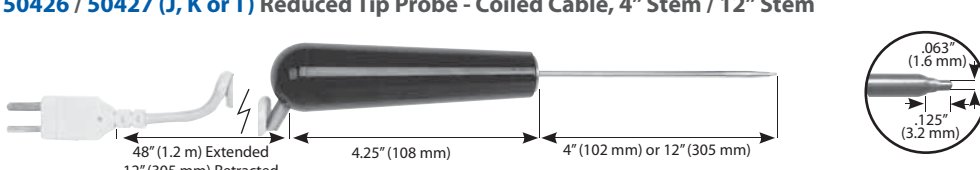

Rugged design for insertion/immersion applications where high temperatures are being measured such as food, chemicals and melt temperatures for plastic molding.

<p>49126 (J, K or T) Reduced Tip Probe - Straight Cable, 4" Stem</p> 	<p>Temp Range: 32° to 932°F (0° to 500°C) Max Tip Temp: 932°F (500°C) Max Cable Temp: 400°F (205°C) Max Handle Temp: 325°F (163°C) Response Time: 1 second, liquid Unit Weight: 4 oz. (113 gms.) Flexible Cable with Teflon Jacket</p>
<p>49127 (J, K or T) Reduced - Tip - Direct Connect</p> 	<p>Temp Range: 32° to 932°F (0° to 500°C) Max Tip Temp: 932°F (500°C) Response Time: 1 second, liquid Unit Weight: .5 oz. (14 gms.)</p>
<p>50426 / 50427 (J, K or T) Reduced Tip Probe - Coiled Cable, 4" Stem / 12" Stem</p> 	<p>Temp Range: 32° to 932°F (0° to 500°C) Max Tip Temp: 932°F (500°C) Max Cable Temp: 176°F (80°C) Max Handle Temp: 325°F (163°C) Response Time: 1 second, liquid Unit Weight: 5 oz. (142 gms.) Coiled Retractable Cable</p>

FINE TIP NEEDLE PROBES

Designed to provide the quickest response with minimal impact on the products. Ideal for small, semi-solid or liquid products such as hamburger patties, shrimp and mushrooms. Probe tips are delicate and should be used by trained personnel.

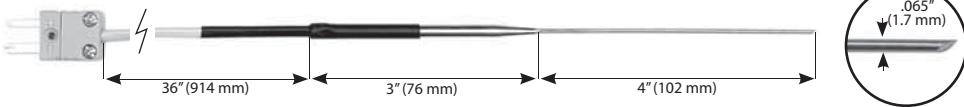
Thin probes respond quickly, but are often fragile. Be cautious when using excessive force while inserting the probe into material to be measured.

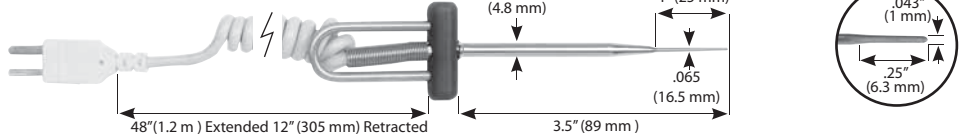
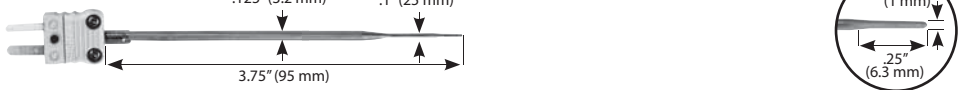
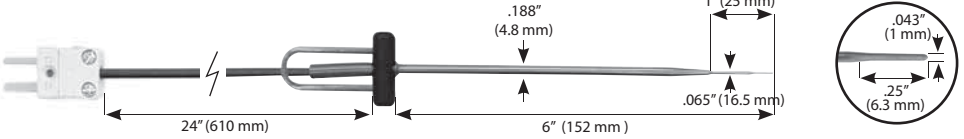
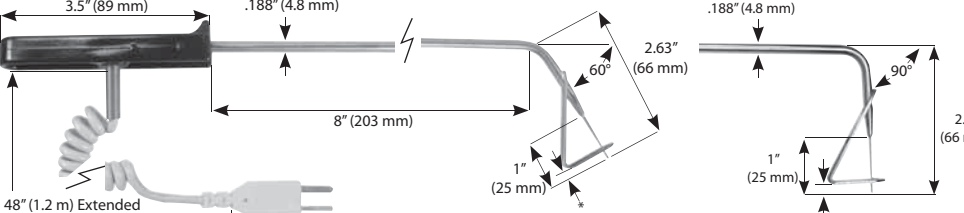
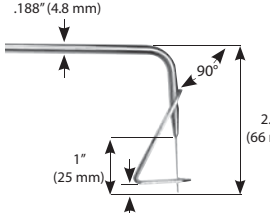
<p>49122 (J, K or T) Ultra Fine Product Probe - Chisel Tip</p> 	<p>Temp Range: -100° to 500°F (-73° to 260°C) Max Tip Temp: 500°F (260°C) Max Cable Temp: 221°F (105°C) Response Time: 3 seconds, liquid Unit Weight: 1 oz. (28 gms.) Flexible Cable with PVC Jacket</p>
<p>50207 (J, K or T) Micro Needle - Chisel Tip</p> 	<p>Temp Range: -100° to 500°F (-73° to 260°C) Max Tip Temp: 500°F (260°C) Response Time: 1 second, liquid Unit Weight: .5 oz. (14 gms.)</p>
<p>50209 (J, K or T) Micro Needle - Rounded Tip</p> 	<p>Temp Range: -100° to 500°F (-73° to 260°C) Max Tip Temp: 500°F (260°C) Max Cable Temp: 176°F (80°C) Max Handle Temp: 280°F (138°C) Response Time: 1 second, liquid Unit Weight: 2 oz. (57 gms.) Coiled Retractable Cable</p>
<p>50210-K Micro Needle - Direct Connect</p> 	<p>Temp Range: -100° to 500°F (-73° to 260°C) Max Tip Temp: 500°F (260°C) Response Time: 1 second, liquid Unit Weight: .5 oz. (14 gms.)</p>
<p>50216-K Micro Needle - Straight Cord</p> 	<p>Temp Range: -100° to 500°F (-73° to 260°C) Max Tip Temp: 500°F (260°C) Max Cable Temp: 400°F (205°C) Max Handle Temp: 280°F (138°C) Response Time: 1 second, liquid Unit Weight: 1.5 oz. (43 gms.) Flexible Cable with Fluoroelastomer Outer Jacket</p>
<p>50263-K / 50264-K Patty Probe</p>  <p>50293-K / 50294-K</p>  <p>* Patty Probes are available with 3/16" or 1/4" insertion needle lengths.</p>	<p>50263-K / 50264-K 60° Angle 50293-K / 50294-K 90° Angle Temp Range: -100° to 500°F (-73° to 260°C) Max Tip Temp: 500°F (260°C) Max Cable Temp: 176° (80°C) Max Handle Temp: 500°F (260°C) Response Time: 1 second, liquid Unit Weight: 3 oz. (85 gms.) Coiled Retractable Cable</p>

VAT PROBES

Designed for immersion temperatures and ideal for continuous monitoring of cooking products. Ideal for deep fryers, large kettle cooking and vat temperatures.

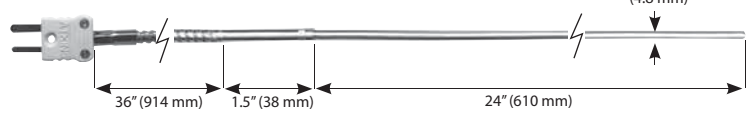
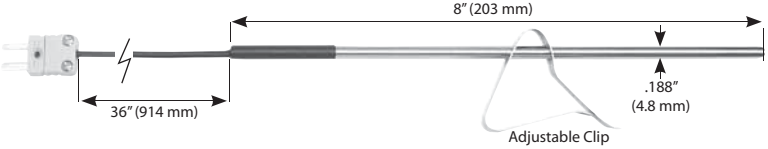
<p>49140 (J, K or T) High Temperature Probe</p> 	<p>Temp Range: 32° to 2012°F (0° to 1100°C) Max Tip Temp: 2012°F (1100°C) Max Cable Temp: 400°F (205°C) Response Time: 2 seconds, liquid Unit Weight: 6 oz. (170 gms.) Flexible Armored Cable</p>
<p>50200 (J, K or T) Cooking Vat Probe</p> 	<p>Temp Range: -40° to 400°F (-40° to 205°C) Max Tip/Cable Temp: 400°F (205°C) Response Time: 12 seconds, liquid Unit Weight: 2 oz. (57 gms.) Flexible Cable with Teflon Jacket Can be secured to the side of a pot or vat. Clip slides up and down probe shaft for depth adjustment.</p>

VAT PROBES

50208 (J, K or T) Fry Vat Probe

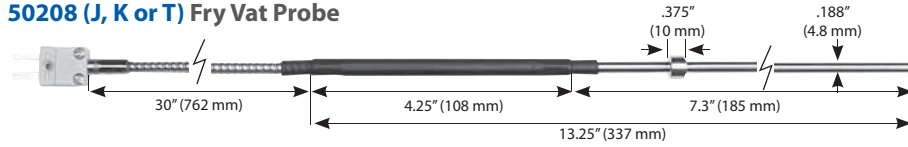

Temp Range: -40° to 400°F (-40° to 205°C)
 Max Tip/Cable Temp: 400°F (205°C)
 Response Time: 8 seconds, liquid
 Unit Weight: 3 oz. (85 gms.)
 Flexible Armored Cable

AIR PROBES

Suitable for measuring air temperatures. Some are hand-held probes designed to measure the ambient air temperature. Other models are designed to monitor internal oven temperatures and include a clip for attaching the sensor inside an oven. The same probes are also capable of measuring freezer and cooler temperatures. Make sure to check each model for usage, recommendations and maximum temperature limits.

Air has very little thermal conductivity and density so probe response time may seem quite slow. To achieve a more rapid response in air, wave the probe tip back and forth to obtain air motion over the measurement tip.

6030MK Bead Probe

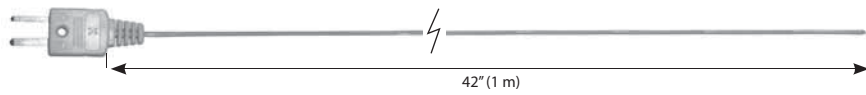

Temp Range: -100° to 500°F (-73° to 260°C)
 Max Tip/Cable Temp: 500°F (260°C)
 Response Time: .5 seconds
 Unit Weight: .3 oz. (8.5 gms.)
 Flexible Teflon Outer Jacket

31903-K Hand Held Air Probe - Petite Handle

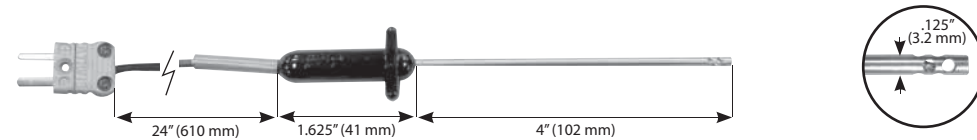

Temp Range: -40° to 400°F (-40° to 205°C)
 Max Tip/Cable Temp: 400°F (205°C)
 Max Handle Temp: 300°F (149°C)
 Response Time: 9 seconds in 5m/sec. air stream
 Unit Weight: 1 oz. (28 gms.)
 Flexible Cable with Silicone Jacket

39032 (J, K or T) Hand Held Air Probe - Straight Cable

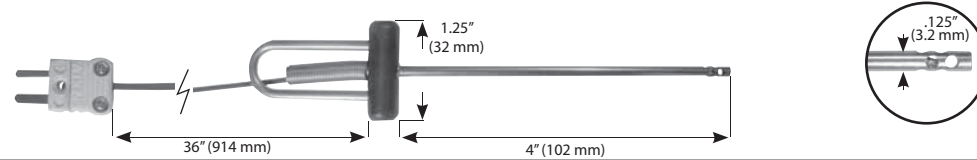

Temp Range: -328° to 400°F (-200° to 205°C)
 Max Tip/Cable Temp: 400°F (205°C)
 Max Handle Temp: 280°F (138°C)
 Response Time: 11 seconds in 5m/sec. air stream
 Unit Weight: 1 oz. (28 gms.)
 Flexible Cable with Teflon Jacket

50302 (J, K or T) Industrial Air Probe with Clip

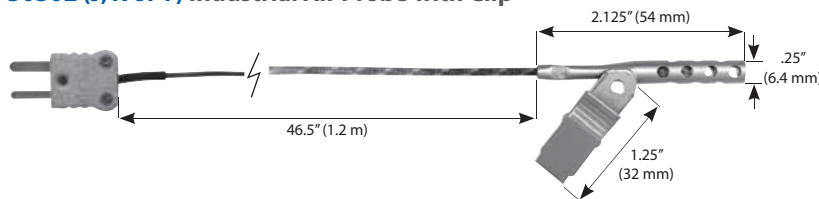

Temp Range: 32° to 896°F (0° to 480°C)
 Max Tip/Cable Temp: 896°F (480°C)
 Response Time: 1 second, liquid, 10 seconds in 5m/sec. air stream
 Unit Weight: 1 oz. (28 gms.)
 Flexible Cable with Fiberglass Jacket
 Note: Not recommended for use in foodservice.

50305 (J, K or T) Freezer / Cooler Probe - Mountable

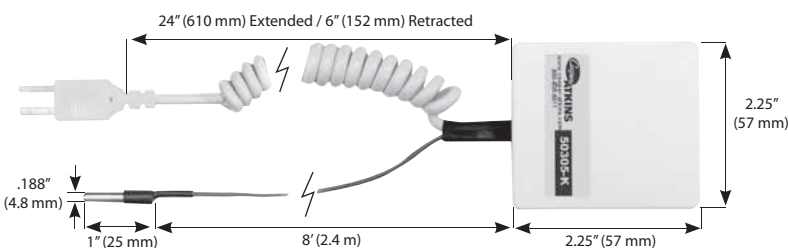

Temp Range: -40° to 400°F (-40° to 205°C)
 Max Tip Temp Sensor Cable: 400°F (205°C)
 Max Coil Cable Temp: 176°F (80°C)
 Response Time: 25 seconds, air
 Unit Weight: 3 oz. (85 gms.)
 Coil Retractable Cable and Sensor Cable with Flexible Teflon Jacket

Thermocouple Instrument can be plugged into a junction box for quick temperature measurement without opening the freezer or cooler door.

50306-K Oven / Freezer Probe with Clip

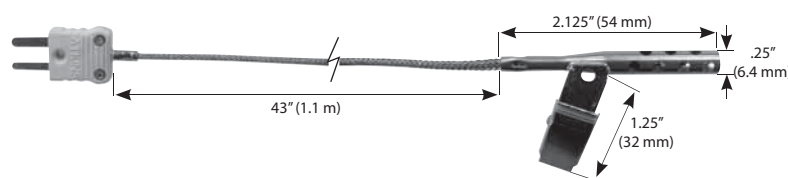

Temp Range: -100° to 600°F (-73° to 316°C)
 Max Temp: 600°F (316°F)
 Response Time: 1 second, liquid, 10 seconds in 5m/sec. air stream
 Unit Weight: 1 oz. (28 gms.)
 Flexible Cable with Woven Stainless steel overbraid

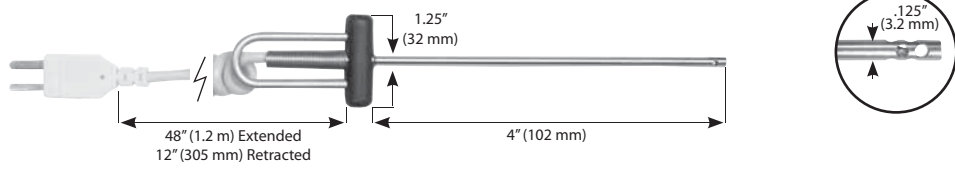
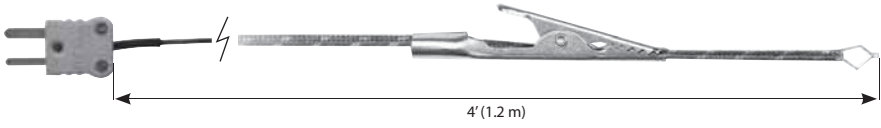
<p>50332 (J, K or T) Hand Held Air Probe - Coiled Cable</p>  <p>48" (1.2 m) Extended 12" (305 mm) Retracted</p> <p>1.25" (32 mm)</p> <p>4" (102 mm)</p> <p>0.125" (3.2 mm)</p>	<p>Temp Range: -100° to 500°F (-73° to 260°C) Max Tip Temp: 500°F (260°C) Max Cable Temp: 176°F (80°C) Handle Temp: 280°F (138°C) Response Time: 10 seconds in 5m/sec. air stream Unit Weight: 2 oz. (57 gms.) Coiled Retractable Cable</p>
<p>50338 (J, K or T) Industrial Air Probe with Alligator Clip</p>  <p>4' (1.2 m)</p>	<p>Temp Range: 32° to 896°F (0° to 480°C) Max Tip/Cable Temp: 896°F (480°C) Response Time: 1 second, liquid: 9 seconds in 5m/sec. air stream Unit Weight: 1 oz. (28 gms.) Flexible Cable with Fiberglass Jacket & Movable Clip. Note: Not recommended for use in foodservice.</p>

SURFACE PROBES

Suitable for measuring temperatures on a variety of surfaces. Griddles or grills should be checked to ensure that proper cooking temperatures are met. Various types of equipment including motors, compressors and plastic molds may also be monitored.

Surface temperatures are the most difficult to measure accurately, especially on poor heat-conducting materials such as paper and some plastic films. It is not practical to estimate the temperature within a solid by measuring the temperature on its surface.

The major source of error surface temperature readings is in obtaining adequate heat transfer from the surface into the measuring probe tip. To reduce this error: 1) use a small amount of oil or grease, if at all possible to improve heat transfer into the tip; 2) use as large of a contact area as practical - a big "footprint"; 3) the probe tip's surface needs to press firmly against the measured surface.

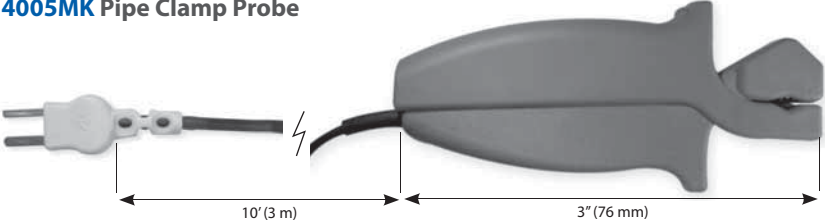
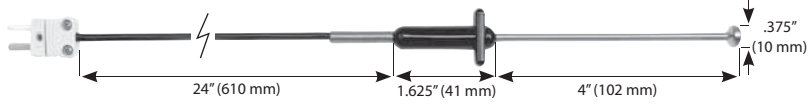
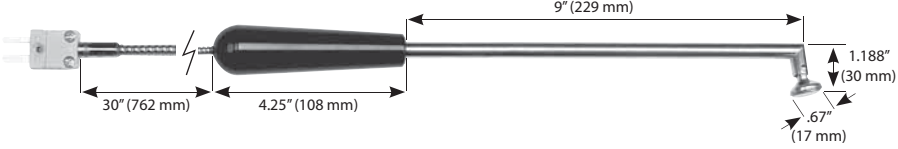
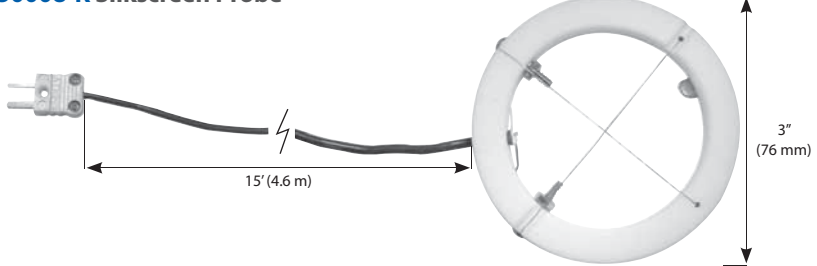
<p>4005MK Pipe Clamp Probe</p>  <p>10' (3 m)</p> <p>3" (76 mm)</p>	<p>Temp Range: -20° to 300°F (-29° to 149°C) Max Tip Temp: 300°F (149°C) Max Cable Temp: 200°F (93°C) Response Time: 2 seconds, on pipe Unit Weight: 7 oz. (198 gms.) Thermo Plastic Elastomer Straight Cable</p>
<p>31907-K Surface Probe - Petite Handle</p>  <p>24" (610 mm)</p> <p>1.625" (41 mm)</p> <p>4" (102 mm)</p> <p>0.375" (10 mm)</p>	<p>Temp Range: -40° to 400°F (-40° to 205°C) Max Tip/Cable Temp: 400°F (205°C) Max Handle Temp: 300°F (149°C) Response Time: 5 seconds, oiled surface Unit Weight: 1 oz. (28 gms.) Flexible Cable with Silicone Jacket</p>
<p>50001 (J, K or T) Right Angle Bell Surface Probe</p>  <p>30" (762 mm)</p> <p>4.25" (108 mm)</p> <p>9" (229 mm)</p> <p>1.188" (30 mm)</p> <p>0.67" (17 mm)</p>	<p>Temp Range: -40° to 400°F (-40° to 205°C) Max Tip/Cable Temp: 400°F (205°C) Max Handle Temp: 325°F (163°C) Response Time: 7 seconds, oiled surface Unit Weight: 6 oz. (170 gms.) Flexible Armored Cable Designed for use on any flat surface. Bell self-ori-ents to the surface, giving superior contact. Ideal for griddle and platens.</p>
<p>50008-K Silkscreen Probe</p>  <p>15' (4.6 m)</p> <p>3" (76 mm)</p>	<p>Temp Range: -40° to 400°F (-40° to 205°C) Max Tip/Cable Temp: 400°F (205°C) Response Time: 1 second, in liquid Unit Weight: 3 oz. (85 gms.) Silicone Outer Jacket Teflon Ring Replacement wires, springs and sinkers sold separately, item 10830 Designed to measure actual ink temperatures to profile dryers.</p>

SURFACE PROBES

50010 (J, K or T) Tape Surface Probe

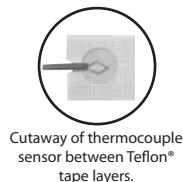
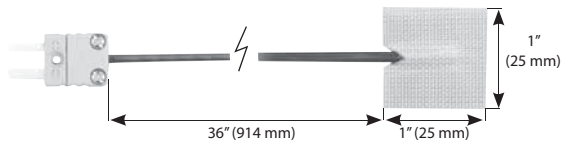

Temp Range: -40° to 400°F (-40° to 205°C)
 Max Tip/Cable Temp: 400°F (205°C)
 Response Time: 9 seconds on metal surface
 Unit Weight: 1 oz. (28 gms.)
[Flexible Cable with Teflon Jacket](#)
 Can be placed between packs of food or cartons. Also suitable for platens.

50012 (J, K or T) 120° Angled Shaft Surface Bell Probe

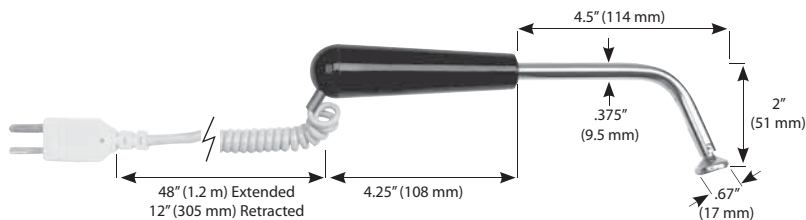

Temp Range: -40° to 500°F (-40° to 260°C)
 Max Tip Temp: 500°F (260°C)
 Max Cable Temp: 176°F (80°C)
 Max Handle Temp: 325°F (163°C)
 Response Time: 4 seconds, oiled surface
 Unit Weight: 5 oz. (142 gms.)
[Coiled Retractable Cable](#)
 Designed for use on any flat surface. Bell self-ori-ents to the surface, giving superior contact. Ideal for griddle and platens.

50014 (J, K or T) Weighted Griddle Surface Probe

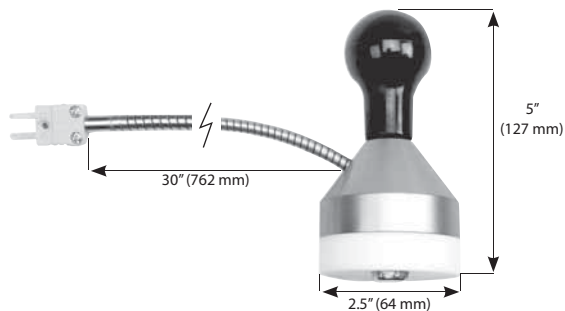

Temp Range: -40° to 500°F (-40° to 260°C)
 Max Tip Temp: 500°F (260°C)
 Max Cable Temp: 400°F (205°C)
 Max Handle Temp: 325°F (163°C)
 Response Time: 2 seconds, oiled surface
 Unit Weight: 2 lb (907 gms.)
[Flexible Armored Cable](#)
 Weighted probe allows hands-free use.

50069 (J, K or T) Moving Surface Bow Probe - Replaceable Sensor

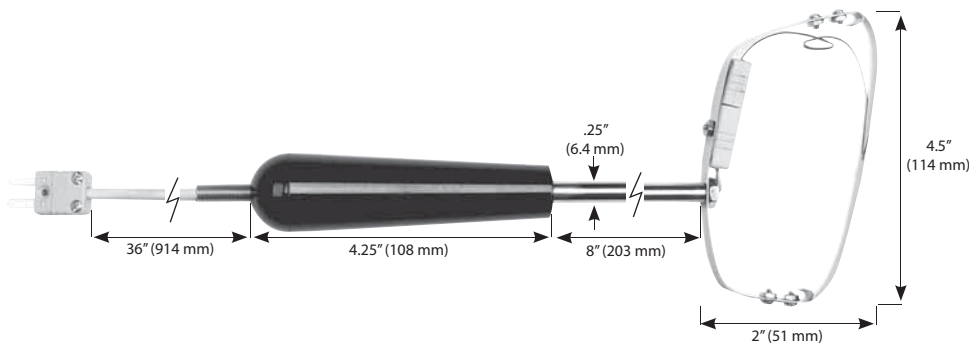

Temp Range: -40° to 500°F (-40° to 260°C)
 Max Tip Temp: 500°F (260°C)
 Max Cable Temp: 221°F (105°C)
 Max Handle Temp: 325°F (163°C)
 Response Time: 4 seconds, oiled surface
 Replaceable Sensor:
 MD3132-10 (Type K);
 MD3132-8 (Type J)
 MD3132-12 (Type T)
 Unit Weight: 6 oz. (170 gms.)
[Flexible Cable with PVC Jacket](#)
 Designed for moving surfaces and rollers. Gives a more accurate rate of measurement on moving surfaces than a standard surface probe.

50316 (J, K or T) 1/8" Surface / Immersion Probe - Flat Tip

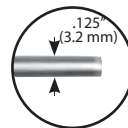
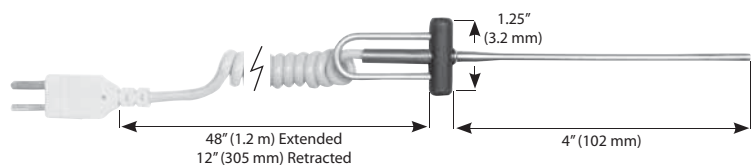

Temp Range: -100° to 500°F (-73° to 260°C)
 Max Tip Temp: 500°F (260°C)
 Max Cable Temp: 176°F (80°C)
 Max Handle Temp: 280°F (138°C)
 Response Time: 6 seconds, oiled metal surface; 1 second, liquid
 Unit Weight: 2 oz. (57 gms.)
[Coiled Retractable Cable](#)
 This probe has a flat tip for surface temperatures, but is also a very fast immersion probe. Not recommended for use in highly acidic or alkaline products such as citrus and tomato products.

50318 (J, K or T) Ceramic Tip Surface Probe

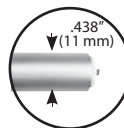
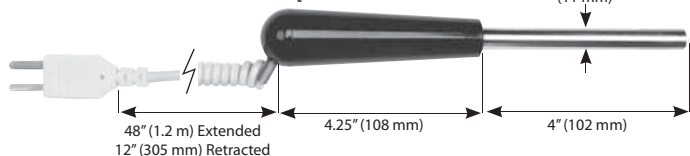

Temp Range: -40° to 1202°F (-40° to 650°C)
 Max Tip Temp: 1202°F (650°C)
 Max Cable Temp: 176°F (80°C)
 Max Handle Temp: 325°F (163°C)
 Response Time: 1 second, oiled surface
 Unit Weight: 5 oz. (141 gms.)
[Coiled Retractable Cable](#)

SURFACE PROBES

<p>50319 (J, K or T) Ceramic Tip Surface Probe - Right Angle</p>	<p>Temp Range: -40° to 1202°F (-40° to 650°C) Max Tip Temp: 1202°F (650°C) Max Cable Temp: 176°F (80°C) Max Handle Temp: 325°F (163°C) Response Time: 1 second, oiled surface Unit Weight: 6 oz. (170 gms.) Coiled Retractable Cable</p>
<p>50405-K Blunt Tip Probe</p>	<p>Temp Range: -100° to 500°F (-73° to 260°C) Max Tip Temp: 500°F (260°C) Response Time: 6 seconds, oiled surface 1 second, liquid immersion Unit Weight: .5 oz. (14 gms.)</p>

MISCELLANEOUS PROBES

<p>31905-K Bare Tip Probe - Silicone Jacket</p>	<p>Temp Range: -40° to 400°F (-40° to 205°C) Max Tip/Cable Temp: 400°F (205°C) Response Time: 1 second, liquid; 3 seconds in 5 m/sec air. Unit Weight: 1 oz. (28 gms.) Flexible Cable with Silicone Jacket Bare tip probe for immersion or air temperatures.</p>
<p>39138 & 50416 (J, K or T) Bare Tip Probe - Teflon® Cable</p>	<p>Temp Range: -328° to 400°F (-200° to 205°C) Max Tip/Cable Temp: 400°F (205°C) Response Time: 1 second, liquid; 7 seconds in 5m/sec. air stream Unit Weight: 1 oz. (28 gms.) Flexible Cable with Teflon Jacket Can measure immersion or air temperatures, or can be installed in substrates of surfaces. Can be embedded in products for freezing and heating studies.</p>
<p>49138 (J, K or T) Bare Tip Probe - Fiberglass Cable</p>	<p>Temp Range: 32° to 896°F (0° to 480°C) Max Tip/Cable Temp: 896°F (480°C) Response Time: 1 second, liquid; 9 seconds, in 5m/sec. air stream Unit Weight: 1 oz. (28 gms.) Flexible Cable with Fiberglass Jacket Note: Not recommended for use in foodservice. Can measure immersion or air temperatures, or can be installed in substrates of surfaces. Can be embedded in products for freezing and heating studies.</p>
<p>49136 (J, K or T) Bendable Tip Probe</p>	<p>Temp Range: 32° to 1652°F (0° to 900°C) Max Tip Temp: 1652°F (900°C) Max Cable Temp: 221°F (105°C) Response Time: 1 second, liquid Unit Weight: 1 oz. (28 gms.) Flexible Cable with PVC Jacket MgO filled stainless steel stem is bendable, ideal for air or liquid temperatures in which quick response is desired or higher temperatures are being measured.</p>

MISCELLANEOUS PROBES

50121 (J, K or T) Racing Tire Probe - Fine Needle Tip

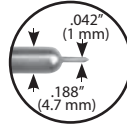
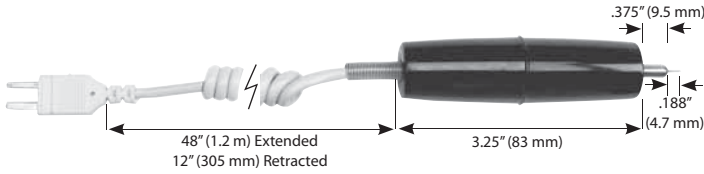

Temp Range: -40° to 500°F (-40° to 260°C)
 Max Tip Temp: 500°F (260°C)
 Max Cable Temp: 176°F (80°C)
 Max Handle Temp: 325°F (163°C)
 Response Time: 1 second, liquid
 Unit Weight: 4 oz. (113 gms.)
 Coiled Retractable Cable

Designed to provide the quickest response with minimal impact on the product.

50415-K Dishwasher Probe

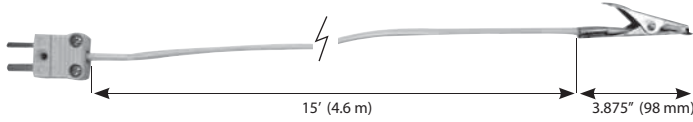

Temp Range: -67° to 221°F (-55° to 105°C)
 Max Tip/Cable Temp: 221°F (105°C)
 Response Time: 9 seconds in 5m/sec. air stream
 Unit Weight: 3 oz. (85 gms.)
 PVC Jacketed Straight Cable

50701-K Combo Probe

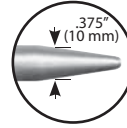
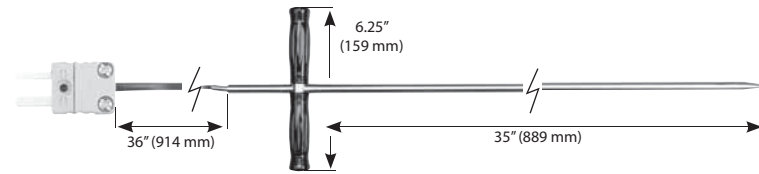

Temp Range: -100° to 500°F (-73° to 260°C)
 Max Tip Temp: 500°F (260°C)
 Max Cable Temp: 400°F (205°C)
 Max Handle Temp: 150°F (65°C)
 Response Time: 2 seconds, liquid
 Unit Weight: 15 oz. (425 gms.)
 Flexible Cable with Fluoroelastomer Jacket

The long combo probe is ideal for measuring large cooking kettles, vats or compost.

REPLACEMENT PROBES FOR 350 SERIES THERMOCOUPLE WRAP&STOW INSTRUMENTS

55032 / 55032-N DuraNeedle Probe

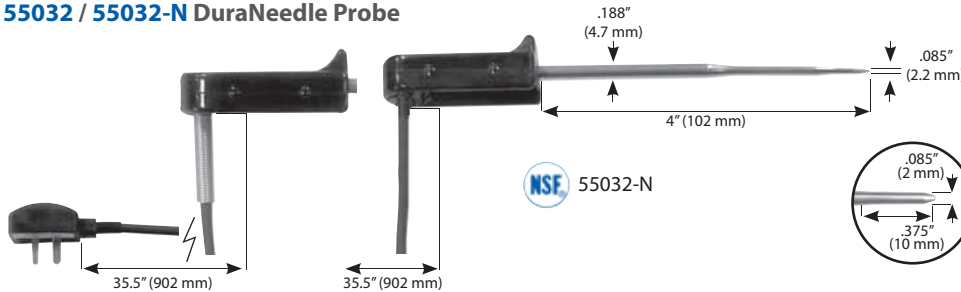

NSF 55032-N

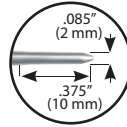

Temp Range: -100° to 500°F (-73° to 260°C)
 Max Tip Temp: 500°F (260°C)
 Max Cable/Handle Temp: 400°F (205°C)
 Response Time: 1 second, liquid
 Unit Weight: 2 oz. (57 gms.)
 Flexible Cable with Fluoroelastomer Outer Jacket
 55032-N is the replacement probe for NSF approved Instruments
 55032 with more robust spring strain relief, is not NSF approved.

Designed to measure dense meats, soft foods and liquids.

55035 Surface Probe

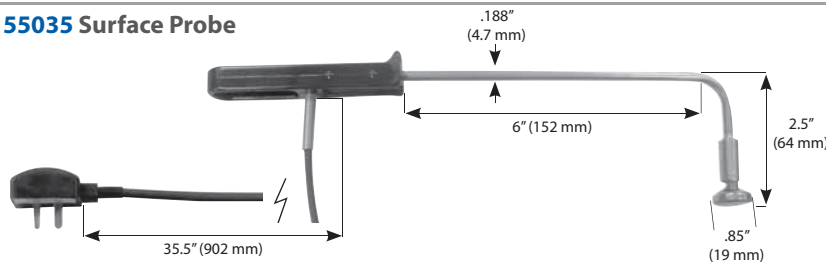

Temp Range: -40° to 500°F (-40° to 260°C)
 Max Tip Temp: 500°F (260°C)
 Max Cable/Handle Temp: 400°F (205°C)
 Response Time: 2 seconds, oiled surface
 Unit Weight: 3 oz. (85 gms.)
 Flexible Cable with Fluoroelastomer Outer Jacket

55040 / 55040-N MicroNeedle Probe

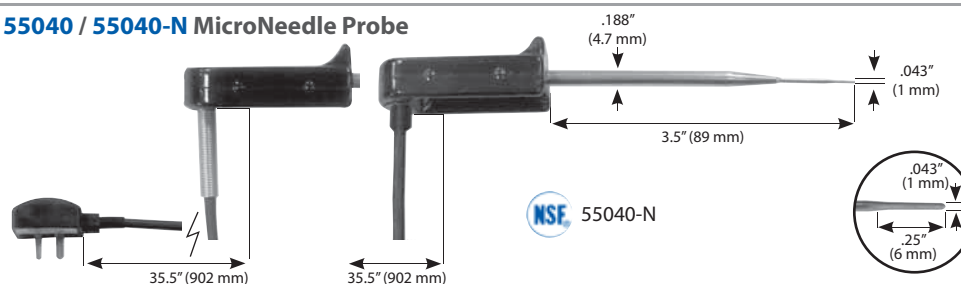

NSF 55040-N

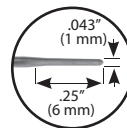

Temp Range: -100° to 500°F (-73° to 260°C)
 Max Tip Temp: 500°F (260°C)
 Max Cable/Handle Temp: 400°F (205°C)
 Response Time: 1 second, liquid
 Unit Weight: 2 oz. (57 gms.)
 Flexible Cable with Fluoroelastomer Outer Jacket
 55040-N is NSF approved when used with 350 series
 55040 with more robust spring strain relief, is not NSF approved.

REPLACEMENT PROBES FOR 330/340 THERMOCOUPLE WRAP&STOW INSTRUMENTS

53032 / 53032-N DuraNeedle Probe 54032 / 54032-N

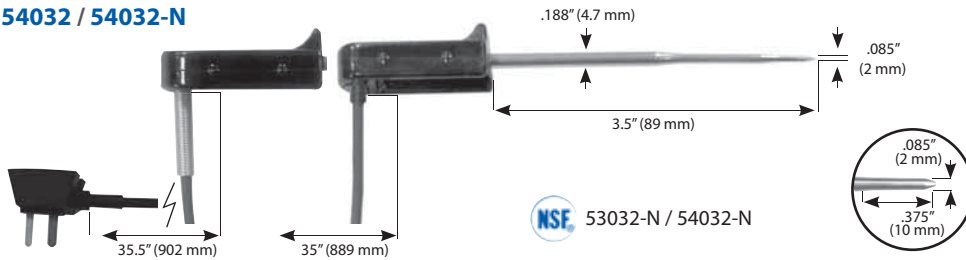

Temp Range: -100° to 500°F (-73° to 260°C)
 Max Tip Temp: 500°F (260°C)
 Max Cable/Handle Temp: 400°F (205°C)
 Response Time: 1 second, liquid
 Unit Weight: 2 oz. (57 gms.)
 Flexible Cable with Fluoroelastomer
 Outer Jacket
 Designed to measure dense meats, soft
 foods and liquids.

53035 / 54035 Surface Probe

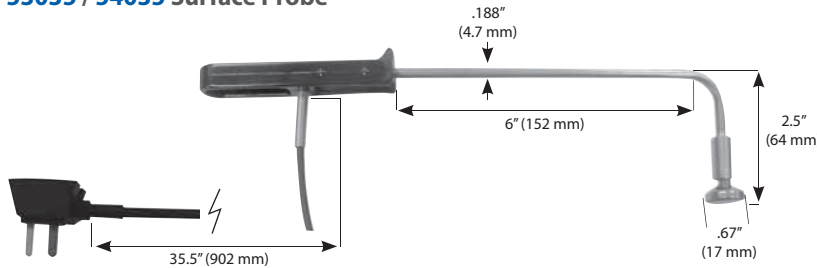

Temp Range: -40° to 500°F (-40° to 260°C)
 Max Tip Temp: 500°F (260°C)
 Max Cable/Handle Temp: 400°F (205°C)
 Response Time: 2 seconds, oiled surface
 Unit Weight: 3 oz. (85 gms.)
 Flexible Cable with Fluoroelastomer
 Outer Jacket

53040 / 53040-N MicroNeedle Probe 54040 / 54040-N



Temp Range: -100° to 500°F (-73° to 260°C)
 Max Tip Temp: 500°F (260°C)
 Max Cable/Handle Temp: 400°F (205°C)
 Response Time: 1 second, liquid
 Unit Weight: 2 oz. (57 gms.)
 Flexible Cable with Fluoroelastomer
 Outer Jacket

CONNECTORS AND EXTENSION CABLES

10040 (J, K or T) Coiled Retractable Extension Cable

Max Temp: 176°F (80°C)
 Unit Weight: 2 oz. (57 gms.)

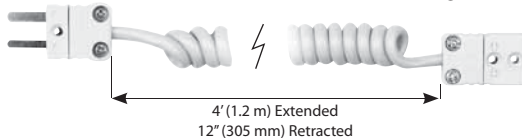

10045 and 10052 (J, K or T) Extension Cables, 20 Ga.

Max Temp: 221°F (105°C)

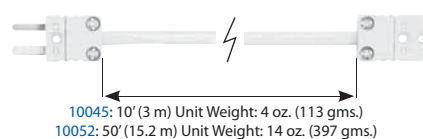

Miniature Thermocouple Connectors

Male: PD 1389-10-K

Female: PD 1389-52-K



Unit Weight: 0.1 oz. (2.8 gms.)
 Also available in J or T

10046 and 10051 (J, K or T)

Extension Cables, Kevlar® Reinforced Max Temp: 400°F (205°C)



10046: 10' (3 m) Unit Weight: 2 oz. (57 gms.)
 10051: 25' (7.6 m) Unit Weight: 5 oz. (142 gms.)

Termometer.se

www.termometer.se

info@termometer.se

08-7530004

>> Klicka för att komma till webshop!!